

Typ	DVW/DHW 450-4E	Artnr.	A26-45009/A36-45009
U	230 V	50 Hz	I <sub>A</sub> / I <sub>N</sub> 2.4
P <sub>I</sub>	0.84 kW	△	IP44
I <sub>N</sub>	3.7 A	✱	01.024
n	1210 min <sup>-1</sup>	■	29.0 kg
C <sub>400V</sub>	16 μF	■	RE/RTE 5
t <sub>R</sub>	40 °C	■	RSE 5.5
Δp <sub>fa min</sub>	-- Pa	▽△	--
ΔI	9	□	MSE1

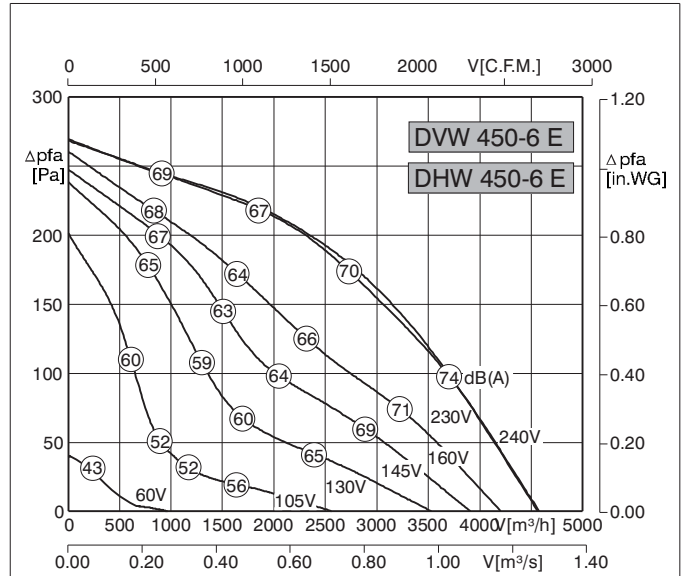

Typ	DVW/DHW 450-6E	Artnr.	A26-45012/A36-45012
U	230 V	50 Hz	I <sub>A</sub> / I <sub>N</sub> 2.4
P <sub>I</sub>	0.37 kW	△	IP44
I <sub>N</sub>	1.9 A	✱	01.024
n	910 min <sup>-1</sup>	■	27.0 kg
C <sub>400V</sub>	6 μF	■	RE/RTE 3.2
t <sub>R</sub>	40 °C	■	RSE 2.5
Δp <sub>fa min</sub>	-- Pa	▽△	--
ΔI	23	□	MSE1

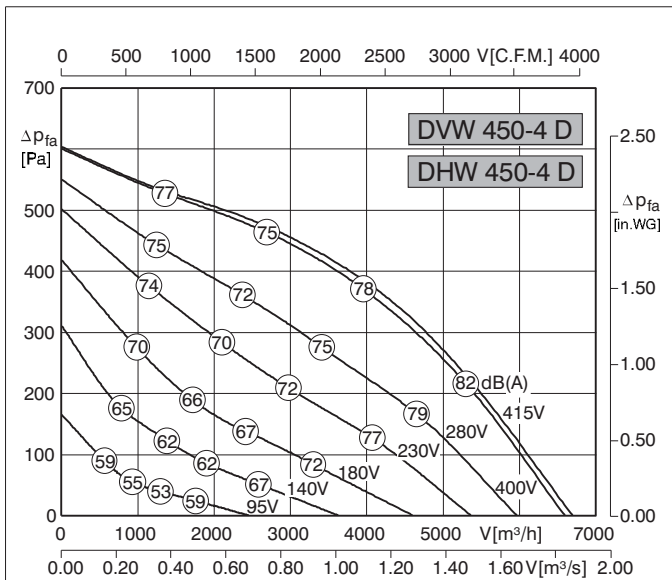

Typ	DVW/DHW 450-4D	Artnr.	A26-45061/A36-45061
U	400 V Δ	50 Hz	I <sub>A</sub> / I <sub>N</sub> 3.3
P <sub>I</sub>	0.94 kW	△	IP44
I <sub>N</sub>	1.7 A	✱	01.006
n	1320 min <sup>-1</sup>	■	29.0 kg
C <sub>400V</sub>	-- μF	■	RTD 2.5
t <sub>R</sub>	40 °C	■	--
Δp <sub>fa min</sub>	-- Pa	▽△	--
ΔI	9	□	MSD1

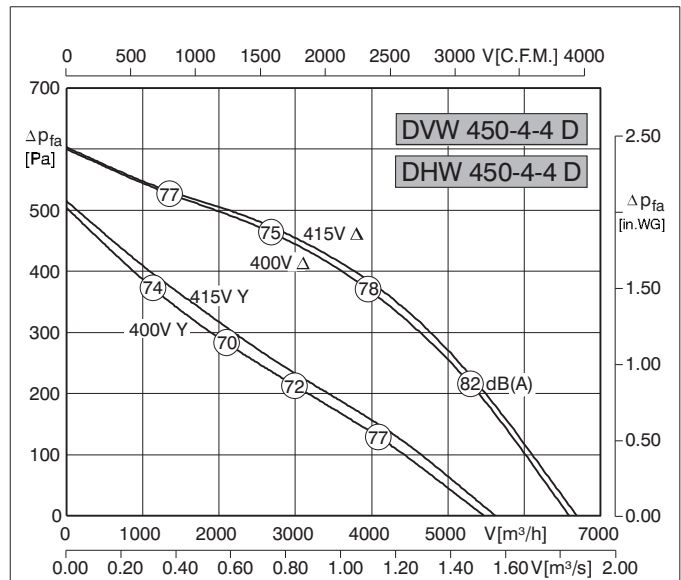

Typ	DVW/DHW 450-4-4D	Artnr.	A26-45067/A36-45067
U	400 V Δ/Y	50 Hz	I <sub>A</sub> / I <sub>N</sub> 3.3
P <sub>I</sub>	0.94/0.62 kW	△	IP44
I <sub>N</sub>	1.7/1.1 A	✱	01.045
n	1320/990 min <sup>-1</sup>	■	29.0 kg
C <sub>400V</sub>	-- μF	■	--
t <sub>R</sub>	40 °C	■	--
Δp <sub>fa min</sub>	-- Pa	▽△	--
ΔI	9	□	MSD 2

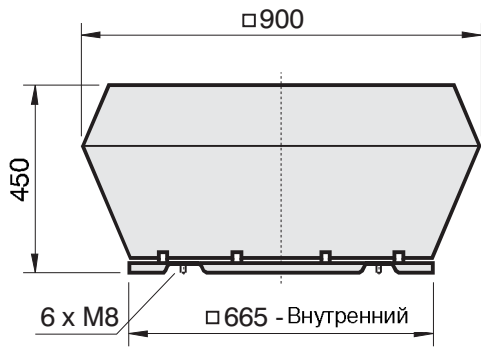

**DVW**

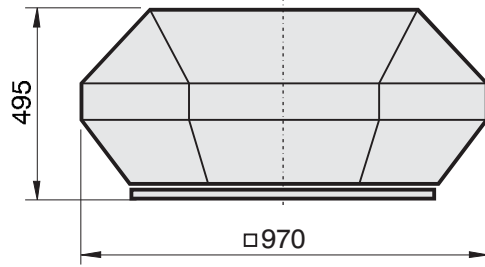

**DVP**

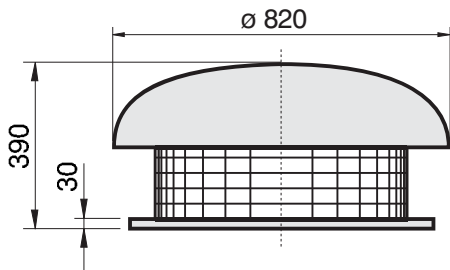

**DHW**

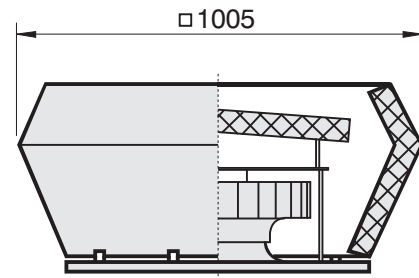

**DVS**

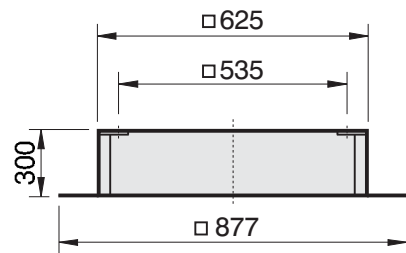
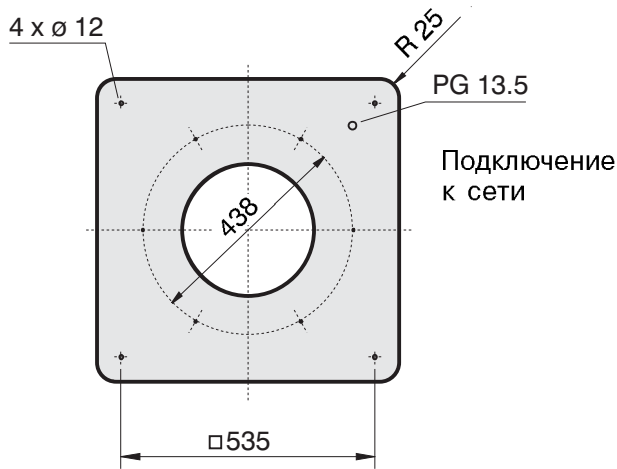

**FS**  
Основание для плоской крыши

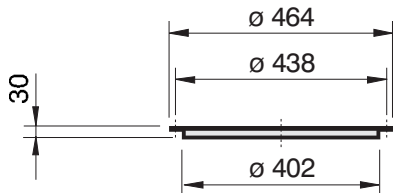

**ASF**  
Фланец со стороны забора воздуха

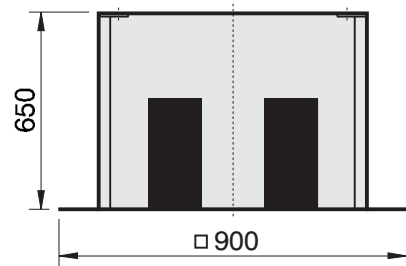

**SD**  
Шумоглушитель для основания

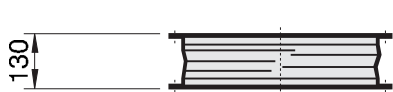

**ASS**  
Патрубок со стороны забора воздуха

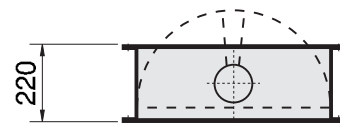

**VM**  
Запорный клапан с электроприводом

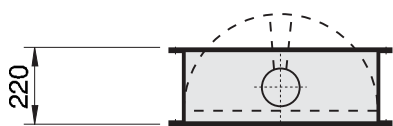

**VS**  
Автоматический запорный клапан

