

Typ	DVW/DHW	450-6D	Artnr.	A26-45063/A36-45063
U	400 V Δ	50 Hz	I _A / I _N	2.6
P ₁	0.31 kW		△	IP44
I _N	0.64 A		✱	01.006
n	880 min ⁻¹		■	26.0 kg
C _{400V}	-- μF		■	RTD 1.2
t _R	70 °C		■	--
Δp _{fa min}	-- Pa		▽△	--
ΔI	--		□	MSD1

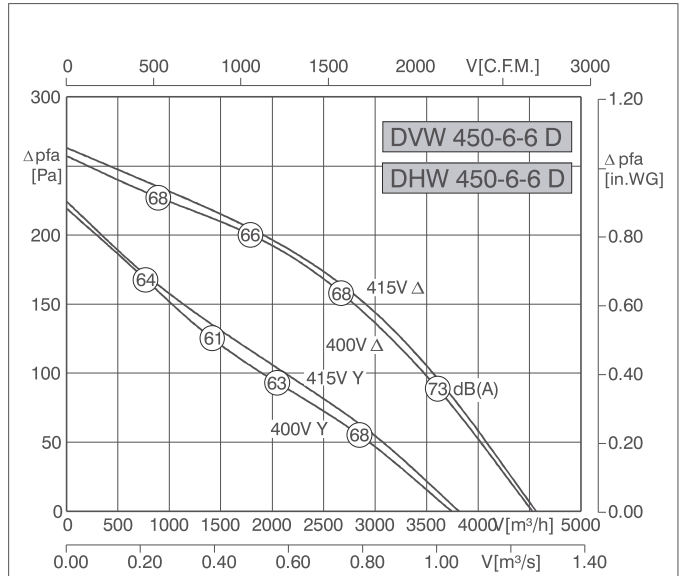

Typ	DVW/DHW	450-6-6D	Artnr.	A26-45069/A36-45069
U	400 V Δ / Y	50 Hz	I _A / I _N	2.6
P ₁	0.31/0.2 kW		△	IP44
I _N	0.64/0.34 A		✱	01.045
n	880/675 min ⁻¹		■	26.0 kg
C _{400V}	-- μF		■	--
t _R	70 °C		■	--
Δp _{fa min}	-- Pa		▽△	--
ΔI	--		□	MSD2

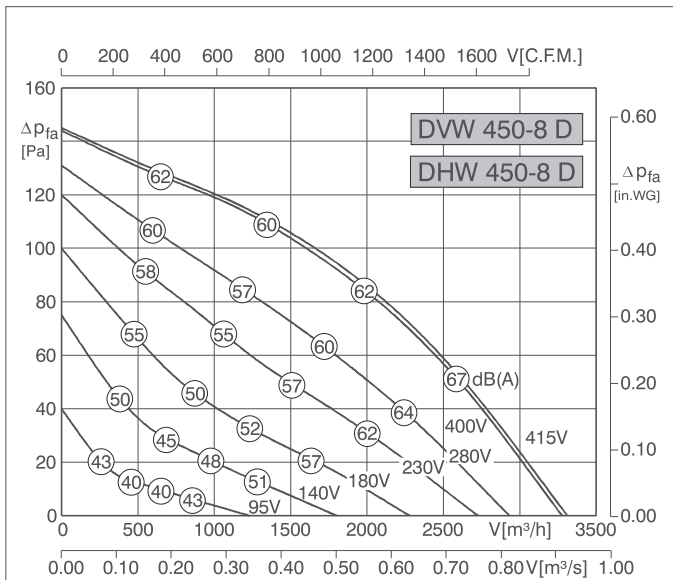

Typ	DVW/DHW	450-8D	Artnr.	A26-45046/A36-45046
U	400 V Δ	50 Hz	I _A / I _N	2.3
P ₁	0.15 kW		△	IP44
I _N	0.34 A		✱	01.006
n	650 min ⁻¹		■	26.0 kg
C _{400V}	-- μF		■	RTD 1.2
t _R	70 °C		■	--
Δp _{fa min}	-- Pa		▽△	--
ΔI	--		□	MSD1

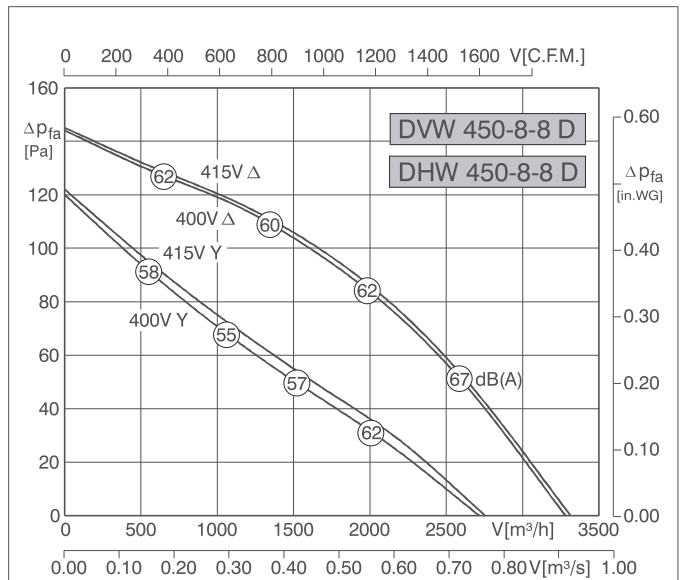

Typ	DVW/DHW	450-8-8D	Artnr.	A26-45071/A36-45071
U	400 V Δ / Y	50 Hz	I _A / I _N	2.3
P ₁	0.15/0.09 kW		△	IP44
I _N	0.34/0.17 A		✱	01.045
n	650/520 min ⁻¹		■	26.0 kg
C _{400V}	-- μF		■	--
t _R	70 °C		■	--
Δp _{fa min}	-- Pa		▽△	--
ΔI	--		□	MSD2

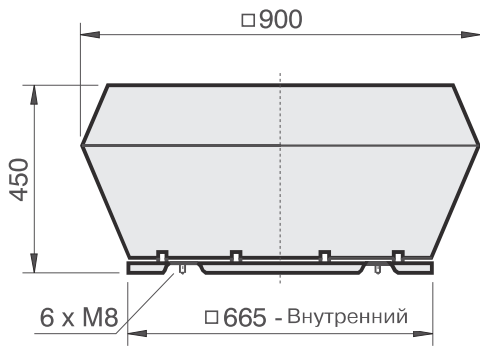

DVW

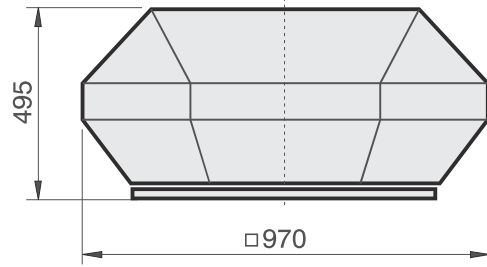

DVP

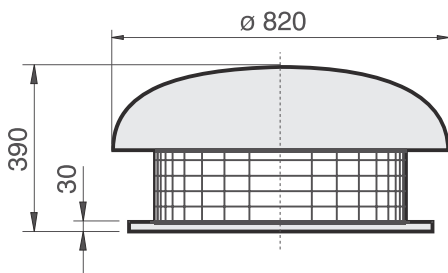

DHW

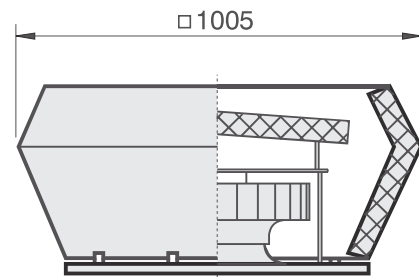

DVS

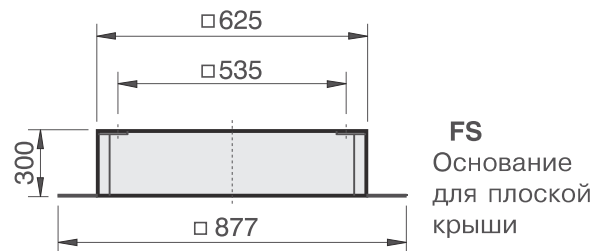
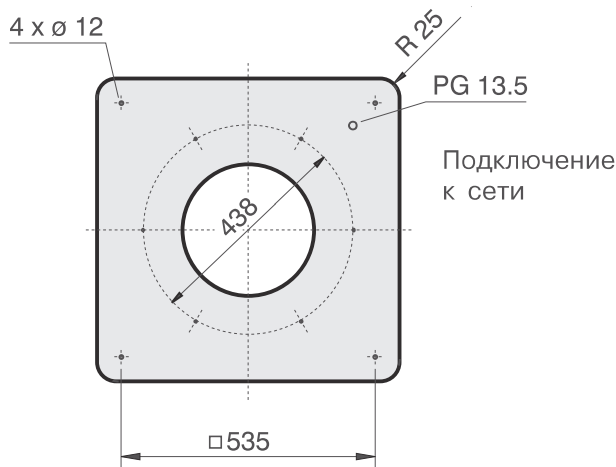

FS
Основание для плоской крыши

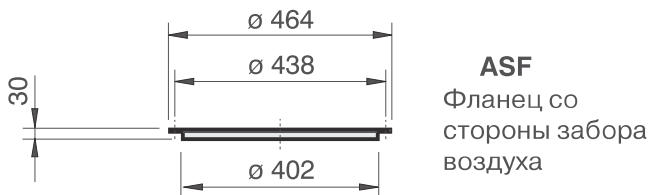

ASF
Фланец со стороны забора воздуха

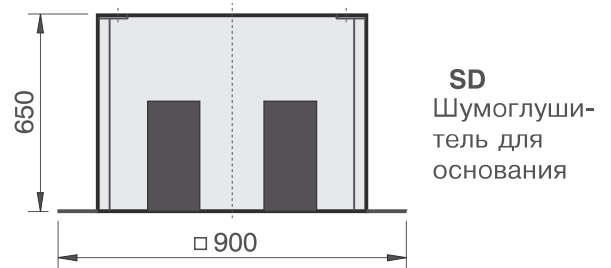

SD
Шумоглушитель для основания

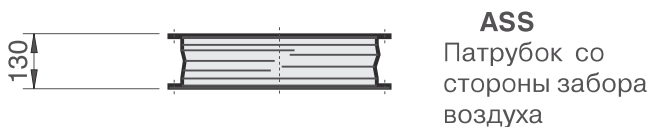

ASS
Патрубок со стороны забора воздуха

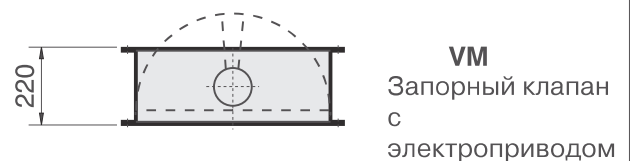

VM
Запорный клапан с электроприводом

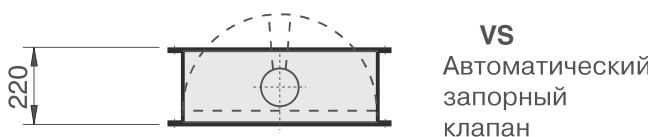

VS
Автоматический запорный клапан

