

Вторник, 25.Июнь 2019



DQ 560-4

Drehstrommotor in Δ -Schaltung mit Thermostatschalter (TB).
Drehrichtungsänderung durch Vertauschen von 2 Phasen.

Three phase motor in delta connection with thermostatic switch (TB). Changing of rotation direction by interchanging of 2 phases.

Moteur triphasé branché en triangle avec interrupteur thermostatique (TB). Changement de sens de rotation par inversion de deux phases.

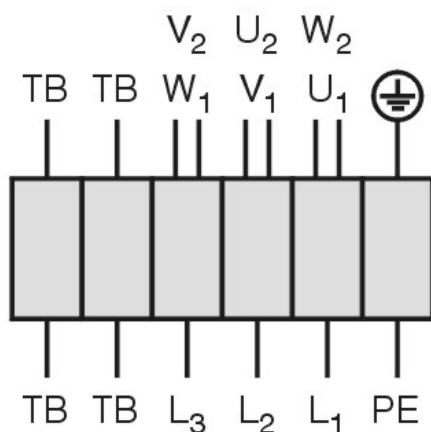

U ₁	braun / brown / brun
V ₁	blau / blue / bleu
W ₁	schwarz / black / noir
U ₂	rot / red / rouge
V ₂	grau / grey / gris
W ₂	orange / orange / orange
TB	weiß / white / blanc
PE	gelb-grün yellow-green jaune-vert

01.006

TK3-20004

Вторник, 25.Июнь 2019

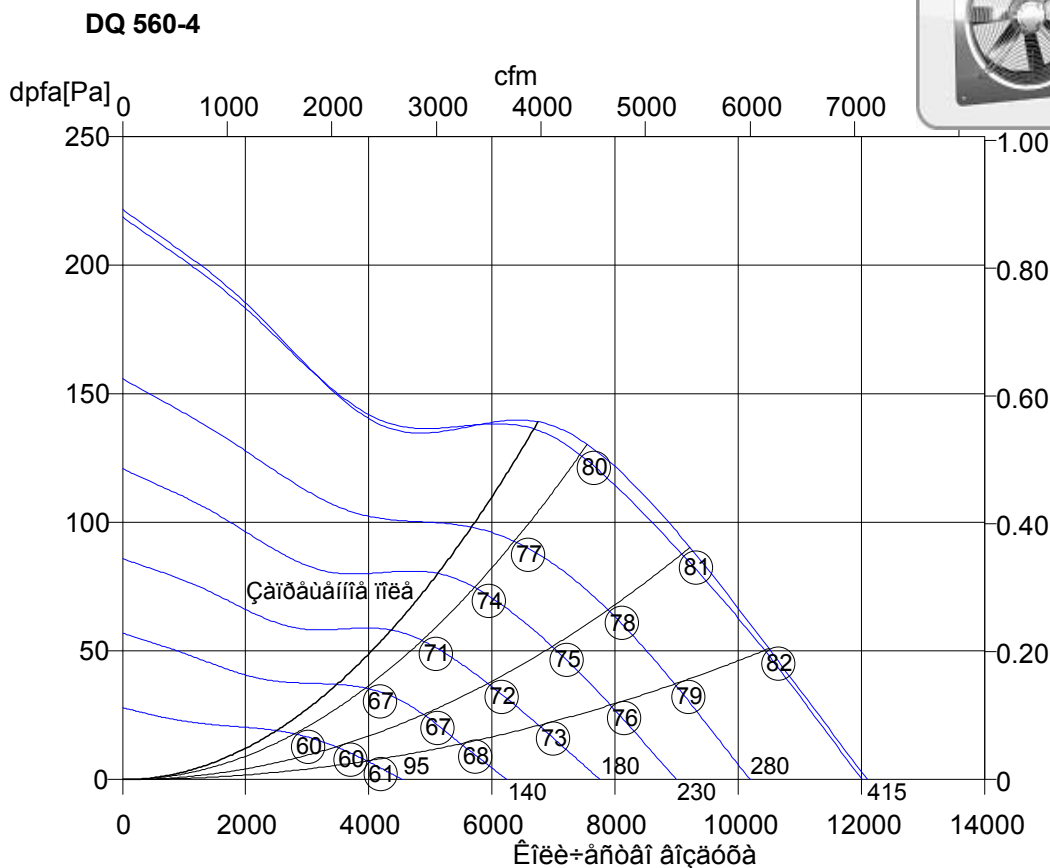

DQ 560-4	
Ном. товар	E00-56053
U[V]	400 D
f[Hz]	50
P[kW]	0.75
I[A]	1.63
n[1/min]	1250
C[μF]	-
tR[°C]	50
dpst[Pa]	-
Delta I[%]	-
Ia/In	2.8
IP	54
Вес[kG]	19.5
Схема сое	01.006ий

○ Уровень мощности звука
 LwA6[dBA]

